

Nominal Size H x W x D (in)	Actual Size H x W x D (in)	Part Number	Capacity (CFM)	Resistance (in W.G.)	Media Area (sq ft)	Carton Qty	Weight per Carton (lbs)
24x24x12	23-3/8 x 23-3/8 x 11-1/2	110-734-001	2000	0.37	108	1	24
24x12x12	23-3/8 x 11-3/8 x 11-1/2	110-734-002	1000	0.37	53	2	29
24x20x12	23-3/8 x 19-3/8 x 11-1/2	110-734-003	1650	0.37	50	1	23
20x16x12	19-3/8 x 15-3/8 x 11-1/2	110-734-004	1100	0.37	58	1	10
20x20x12	19-3/8 x 19-3/8 x 11-1/2	110-734-005	1400	0.37	73	1	13
16x25x12	15-3/8 x 24-3/8 x 11-1/2	110-734-006	1400	0.37	74	1	13
24x18x12	23-3/8 x 17-3/8 x 11-1/2	110-734-007	1500	0.37	80	1	13
20x25x12	19-3/8 x 24-3/8 x 11-1/2	110-734-008	1750	0.37	94	1	15
24x24x6	23-3/8 x 23-3/8 x 5-7/8	110-734-009	1000	0.37	55	2	27
24x12x6	23-3/8 x 11-3/8 x 5-7/8	110-734-010	500	0.37	27	4	34
24x20x6	23-3/8 x 19-3/8 x 5-7/8	110-734-011	825	0.37	46	2	25
20x16x6	19-3/8 x 15-3/8 x 5-7/8	110-734-012	550	0.37	30	2	17
20x20x6	19-3/8 x 19-3/8 x 5-7/8	110-734-013	700	0.37	37	2	24
16x25x6	15-3/8 x 24-3/8 x 5-7/8	110-734-014	700	0.37	38	2	21
24x18x6	23-3/8 x 17-3/8 x 5-7/8	110-734-015	750	0.37	41	2	24
20x25x6	19-3/8 x 24-3/8 x 5-7/8	110-734-016	875	0.37	48	2	26

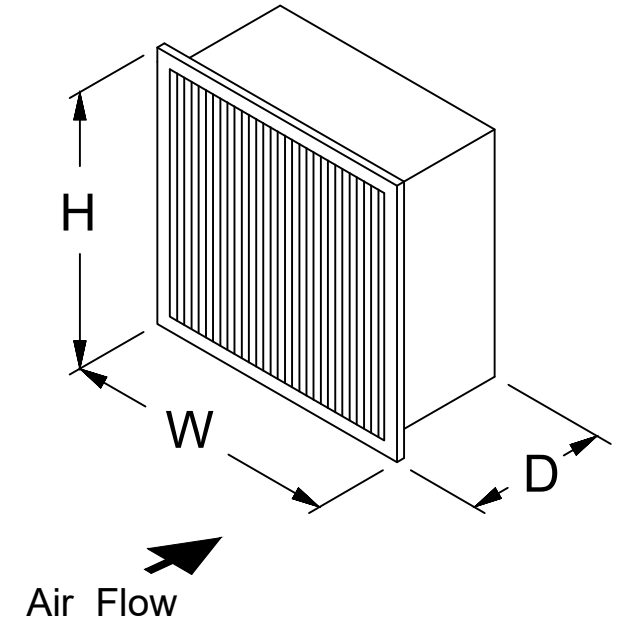

Standard Construction:

1. Gradient Density Microfiberglass Media
2. Frame: 26 gage Galvanized Cellsides
3. Media Separators: Corrugated Aluminum with hemmed safety edge
4. Sealant: Hotmelt used to seal media pack to cell sides
5. Header Depth: 13/16" Standard
6. Header on Upstream Side of filter

Notes:

1. All Dimensions are in Inches Unless Otherwise Noted
2. Drawing Not to Scale

Specifications:

1. MERV 11 (60-65%) (ASHRAE Standard 52.2-2017)
2. Final Resistance: 1.5" W.G.
3. Rated Velocity: 500 FPM - 12" Deep
4. Rated Velocity: 250 FPM - 6" Deep
5. Classified per UL Standard 900
6. Maximum Operating Temperature: 350 F (177 C)
7. Tolerance: Height & Width - +0 / -1/8"
8. Tolerance: Depth - +/- 1/16"

KOCH FILTER
PURE PERFORMANCE

**Multi-Cell FM
MERV 11**

REV
LTR

REVISION

BY /
DATE

8401 Air Commerce Drive - Louisville KY 40219
Phone: (502) 634-4796 FAX: (502) 637-2280

Drawn By: Dave Miller
Date: September 7, 2022

Revision